

# Technical Information

## ROUTER BIT SELECTION, APPLICATION & MAINTENANCE

We have prepared the following guidelines to assist our distributors and customers in the selection, application and maintenance of Amana Tool's® high quality industrial routing tools.



**ALL ROUTER BITS ARE CARBIDE-TIPPED UNLESS STATED OTHERWISE.**

### 1. GENERAL INFORMATION

The router bits contained in this catalog are designed for use in portable or stationary/CNC routing machines only. Do not use router bits in any other equipment such as a drill press, portable electric drill, etc. Conversely, 'Boring Bits', are designed for boring machines and/or drill presses, and not for routing machines or portable drills. Unless specified otherwise, all router bits in this catalog are for clockwise (right hand) rotation.

Always wear proper eye protection while operating routers.

Read and understand all information provided with the particular router you are using. The router should be of high quality and all parts thereof should be well maintained. Keep body, clothing and hair away from all moving parts.

Cutting tools that are properly sharpened and maintained will cut faster, better and longer, and will be safer to use. In addition, less horsepower is required (both machine & operator) when sharp tools are used.

### 2. ROUTER TOOL SELECTION

Carbide router bits provide an excellent finish in solid hard and softwood, wood by-products such as MDF and plywood, and abrasive materials such as plastic, Corian® and other solid surface sheet goods. Under certain conditions, non-ferrous metals such as aluminum

and brass can also be cut using carbide tools provided that a coolant is used and proper clamping devices are employed. Extreme care should be taken when cutting non-ferrous metals, and if you are not familiar with the special cutting properties of these materials, please seek professional advice before you attempt any routing or sawing. **Never** attempt to cut ferrous metals (steel, iron, etc.) with carbide router bits.

Solid steel portions of our tools (shank, tool body) are **turned, milled and ground** (not cast) from the highest quality tool steel available.

**Note:** On certain grinding equipment, **cast body tools** have been known to be more difficult to re-sharpen due to indexing complications. Choose your tools carefully.

Always use the **shortest cutting edge** available that will meet the requirements of your application. Excessive cutting edge length and/or overall length compounds vibration and deflection - a leading cause of tool breakage.

Always use the **largest diameter shank** available that your router will accommodate.

Always use the **correct size collet** for your router and avoid using collet reducing sleeves or bushings. Reducers only add to vibration and run-out, and they generally do not provide the necessary holding capabilities as with a collet alone.

[Router Bit Index \(by type\)](#) pages IV-V. [Router Bit Index \(by number\)](#) pages 290-293.

# Technical Information

ALL ROUTER BITS ARE CARBIDE-TIPPED UNLESS STATED OTHERWISE.



**SINGLE EDGE (1 FLUTE) ROUTER BITS** should be used when the speed of the cut (feed-rate) is primary and the finish is secondary. Available on certain plunge bits.



**SOLID CARBIDE PLASTIC (O) FLUTE 'UP-CUT' AND 'DOWN-CUT' ROUTER BITS** are used to produce super clean cuts, especially in acrylic materials (Plexiglas®, Lucite®), other plastics, solid surface and wood.



**DOUBLE EDGE (2 FLUTE) ROUTER BITS** should be used when the finish is primary and feed-rate is secondary. Most router bits have 2 flutes.



**SOLID CARBIDE ALUMINIUM (O) FLUTE 'UP-CUT' AND 'DOWN-CUT' ROUTER BITS** are specifically designed for cutting aluminum, brass, copper and other non-ferrous metals.



**3° DOWN-SHEAR ROUTER BITS** straight plunge new down-shear plunge with upper ball bearing and Supertrim™ are recommended when the finish from a standard bit is inadequate or the horsepower is low. Shear action cuts a smaller portion of the workpiece at one time due to a radial flute design. Down-shear is not intended to be used 'inverted', as in a router table or shaper. Also see the new 'opposite-shear' bits.



**SOLID CARBIDE ROUTER BITS** (diamond pattern) are recommended for highly abrasive materials such as fiberglass, tile, etc.

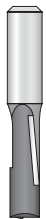

**STAGGER-TOOTH ROUTER BITS** are considered 2 flute but the cutting edge is split (staggered 180°) between the two flutes. These tools combine the speed and chip clearance of one flute bits, with the strength and balance of two-flute bits.



**SPIRAL FLUTE 'UP-CUT' AND 'DOWN-CUT' ROUTER BITS** are recommended for deeper mortising where chip removal is essential to continuing the cut. Also used for some plastics and solid-surface materials such as Corian®, etc.

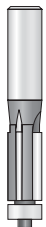

**FLUSH TRIM (2 FLUTE, 3 FLUTE AND 4 FLUTE) ROUTER BITS** are available on some trim bits, spirals and insert bits. This design will provide an extremely smooth finish on certain laminates that tend to chip easily.



**SOLID CARBIDE COMPRESSION SPIRAL BITS** are designed for CNC applications requiring high feed rates and a clean finish. **Particularly suitable for double-sided melamine** or laminated material. Choose either single flute for the highest possible feed rate or double flute for the best finish.



**PANEL PILOT ROUTER BITS** have a plunge point and a pilot that can serve as an edge guide. Generally used by mobile home and trailer manufacturers.



**CHIPBREAKER BITS** can be specially ordered for 3/4" shank CNC applications. Designed to cut chipboard and MDF at high automatic feed-rates found on CNC machines. Each flute is ground so that the chip breakers are staggered to each other, giving a straight cut. (Two flute only). Also available as standard with certain types of spiral bits.



**MORTISING BITS** have a large gullet between the two flutes for better chip removal during mortising type cuts. Screw-type bits are normally used in mortising jigs and door machines.

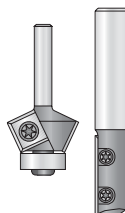

**INSERT TOOLING** should be considered for long-term cost efficiency especially on high-volume or repeated work. Cutter diameters remain constant for a high degree of accuracy and never require re-sharpening. Consult your local dealer or Amana Tool® for a fast cost comparison analysis on insert type tooling.

# Technical Information

ALL ROUTER BITS ARE CARBIDE-TIPPED UNLESS STATED OTHERWISE.

## 3. ROUTER TOOL USAGE

Always use **properly sharpened cutting tools**. The **feed-rate** of a router to the workpiece (or vice-versa if used in a router table) is very important to the longevity of the tool and the overall quality of cut. The operator should feel a constant, even pressure when the work is applied to the cutter. If chattering occurs, stop the router promptly and inspect the router, cutting tool, collet and clamping devices, and ensure that the proper tool is being used for the material being cut.

Always keep the tool moving: allowing the tool to 'dwell' in the cut will cause burning and reduce tool life immensely. Remember, heat can ruin a sharp tool.

**Feed-rate** ultimately depends on three factors: 1) the type of material being cut, 2) the amount of material being removed and 3) the type of tool being used.

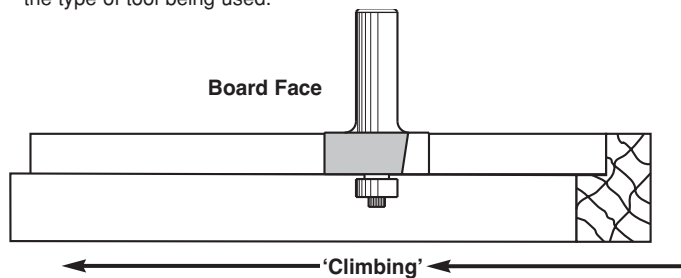

'Climb-cutting' is **not recommended** as a portable routing technique. This action tends to grab the wood and pull the cutting tool in the direction indicated.

If using extremely **large diameter** tools, always accomplish the cut with several passes of the router or, if applicable, remove as much material prior to using the large tool by means of chamfering, etc. This method will increase tool life and generally be a safer practice than trying to remove too much material in one pass. Large diameter router bits should generally be used in a high quality router table.

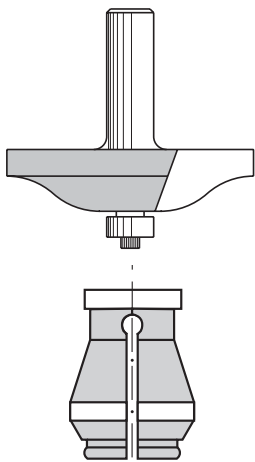

Proper **collet condition** is of extreme importance. Worn, scored or out-of-round router collets do not provide adequate holding power and will increase run-out and vibration. Multiply these factors by the router R.P.M. (22,000 and greater), and you will realize why we must emphasize the importance of proper router collet condition. Do not assume that new collets are geometrically correct. Dark marks or grooves in the router bit shank usually indicate slippage and a worn collet, which should be replaced immediately.

Router bits should always be **completely inserted** into the collet and backed-off slightly (1/16" approx.). **Never partially insert the bit into the collet.** Follow the guidelines provided in your router owners manual for further information regarding this and the appropriate usage of the router base and sub-base (particularly for larger diameter tools that do not clear the standard opening in the router sub-base).

## 4. ROUTER TOOL MAINTENANCE

Carbide tools can be **re-sharpened** many times. Always have your cutting tools re-sharpened by a **reputable grinding firm only**. Do not attempt to sharpen your own router bits by means of files, whetstones, etc.

Keep your cutting tools clean and free of dirt, wood resin, pitch and other contaminants using a standard commercial solvent. A light coat of machine oil should prevent any surface discoloration or rust. Thoroughly wipe clean all shanks to prevent slippage during use.

**Ball Bearings** should not be cleaned with solvents, as this will deteriorate the special grease packed inside them. Rather, use an air gun to blow off any dust or dirt. 'Frozen' ball bearings (ones that do

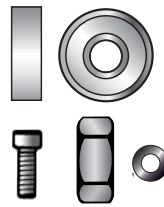

not rotate freely) should be replaced promptly.

**Hardware** (nuts, screws, washers) should be replaced if worn.

See "Replacement Parts" on pages 152-153.

## 5. ROUTER TOOL TERMINOLOGY

**Cutting Diameter ('D')** refers to the largest cutting diameter of the tool and is represented in fractions, decimals and/or millimeters.

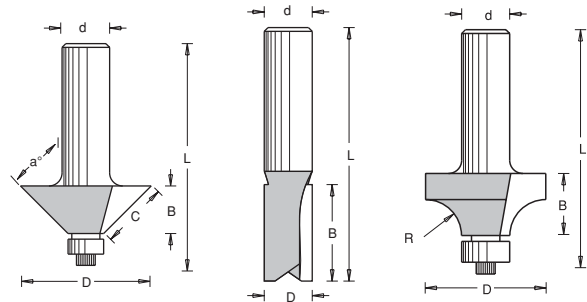

**Cutting Length ('B or C')** refers to the length or 'depth' of the cutting edge. This dimension usually represents the cutting edge length **parallel** to the length of the shank. Represented in fractions and/or millimeters.

**Shank Diameter ('d')** refers to the largest diameter of the shank and is equivalent to the router collet **inside diameter** that is necessary to use the tool. This dimension is represented in fractions.

**Overall Length ('L')** refers to the total length of a router bit from the top of the shank to the bottom of the tool at its furthestmost point. This dimension is represented in fractions and/or millimeters.

**Radius ('R')** of a cutting tool edge refers to one-half the diameter of a complete circle, and is shown in fractions and/or millimeters.

**Bevel Angle ('a°')** refers to the angle formed between the cutting tool edge and a straight line drawn parallel or perpendicular to the shank length, and is measured in degrees.

**Rake Angle ('T')** refers to the angle (or 'hook') of the cutting tool tip in relationship to a straight line drawn perpendicular through the center of

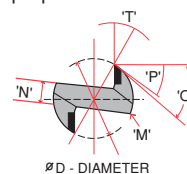

the tool. This dimension is measured in degrees.

**Primary Radial Clearance ('P')** refers to the relief grind on the tip of the tool and is measured in degrees.

**Secondary Radial Clearance ('O')** refers to the combined relief grind of the primary clearance and the clearance ground into the body of the tool. This dimension is measured in degrees.

**Penetration Clearance ('S')** refers to the angle formed between the cutting tool edge and a straight line drawn perpendicular to the shank of the tool, and is measured in degrees. This angle allows gradual penetration into the material.

**Web Diameter ('N')** refers to the thickness of the ground steel body of the tool, including the heel area ('M'). The web must be of adequate thickness to withstand industrial routing applications.

Corian® is a registered trademark of The Dupont Co.

© Copyright 1995,1998, 2000, 2002, 2005, 2007 Amana Tool®.